



PACKAGE 2026

This is the interactive Spanesi's Package 2026.
Click on product name to go directly on its page. To return this
page, click on "BACK TO INDEX" box you find on each
product page.

Sommario

Electra	14	Ponybench BT Plus	46
Michelangelo	15	Ponybench BE 15	47
Giotto	16	Ponybench PR Plus	48
Einstein 1	17	Two post Lift - TP 248	49
Einstein 2	18	Double Scissor Lift - DS 249	50
Mixing box	19	Double Scissor Lift - DS 259	51
Industrial Spray Booth	20	Multibench P3	52
Aluminium booth	21	Multibench P4	53
Buddy	22	Multibench P7	54
Inframatic EVO 2	23	Multibench EXT	55
KITO	24	PULL UP! Light	56
100 TS	25	Flash	57
Jig on the wall	26	Twister 6m	58
106/Universal Jig 5m	28	Typhoon-4B	59
106 Plus	29	Pinocchio 6m Arm	60
106 Ext 6M	30	Pitagora	61
Daytona Plus infloor	31	Trial	62
Spanesi Truck Line - Repair	32	Picasso 3m	63
Spanesi Truck Line - Alignment	33	Furniture	64
Touch 4.0	38	Design	65
Touch Portable	39	VAS Equipment	66
Package Car Check	40	TESLA Equipment	67
Touch One	41		
Minibench 2.5 T	42		
Minibench Maxiplus	43		
Minibench pr maxiplus	44		
Minieco 2.8T	45		



The new Bodyshop Design era

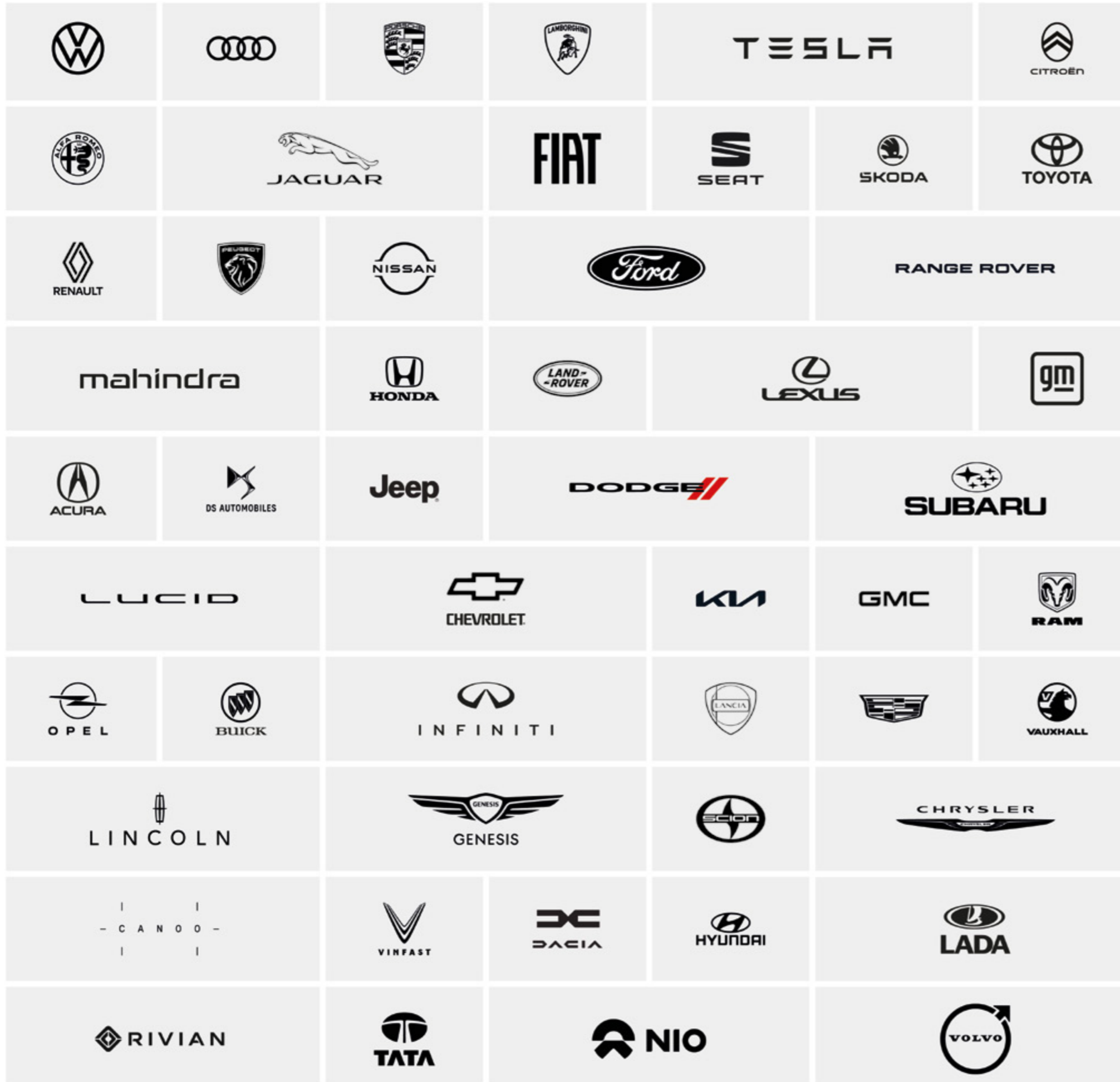

Spanesi Oem Approvals

The list of vehicle manufacturers with Spanesi cooperates with, developing and studying every day the best solutions to arrange an high quality standard for each kind of reparation.

A timeless collision repair tradition.

Spanesi innovates, designs and manufactures the entire range of collision repair equipment. With its worldwide reach incorporating local divisions and a large distribution network, Spanesi is the only manufacturer that owns and operates a collision repair facility at its headquarters, where all products are tested and proven on a daily basis.

Orazio Spanesi, panel beater with a passion for “the tools”, founded Spanesi in 1969. Staying in constant contact with body technicians represents the spirit of the entire Spanesi organization and reflected in its deep collision industry roots. Through the constant pursuit of high efficiency and OEM quality repairs, led Orazio to open his own bodyshop. He then set his sights on manufacturing equipment, with the exceptional insights of thinking like a technician. Spanesi’s mission statement is simple:

Spanesi does not offer tools that collision repair technicians have to adapt to; we make tools tailored to technician’s needs.



[DOWNLOAD SPANESI CORPORATE](#)

[WATCH SPANESI STORY VIDEO](#)



Touch

The Electronic Measuring System

[Play Video](#)



Minibench

Smart. Fast. Powerful.

[Play Video](#)



Flash

The perfect system for smart repairs

[Play Video](#)



MULTIBENCH

Multibench

For small, medium and large damages

[Play Video](#)

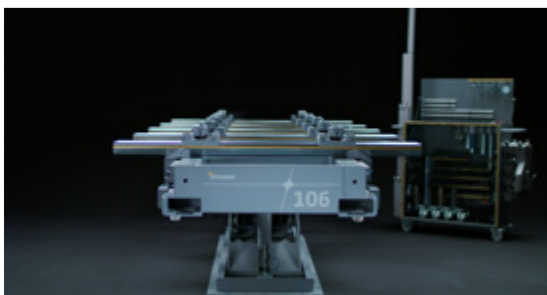

106/Universal Jig

The most advanced Structural Repair Workstation

[Play Video](#)

106/Universal Jig

The complete Tutorial

[Play Video](#)



PULL UP!

Modern repair method

[Play Video](#)



106 and Touch EV car

Ev car repair with universal Jig System

[Play Video](#)



Multibench and Touch EV car

Package 5

[Play Video](#)

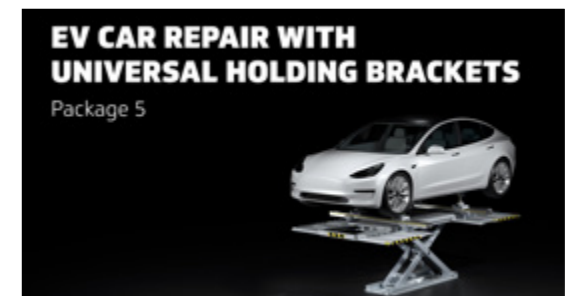

Buddy

Trolley for moving grids

[Play Video](#)

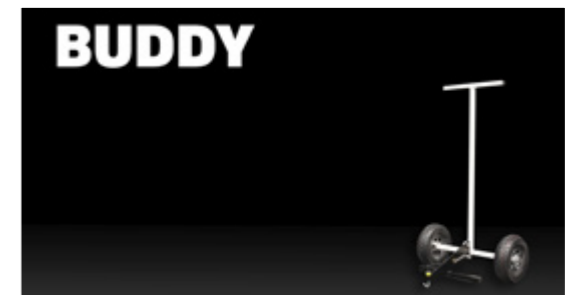

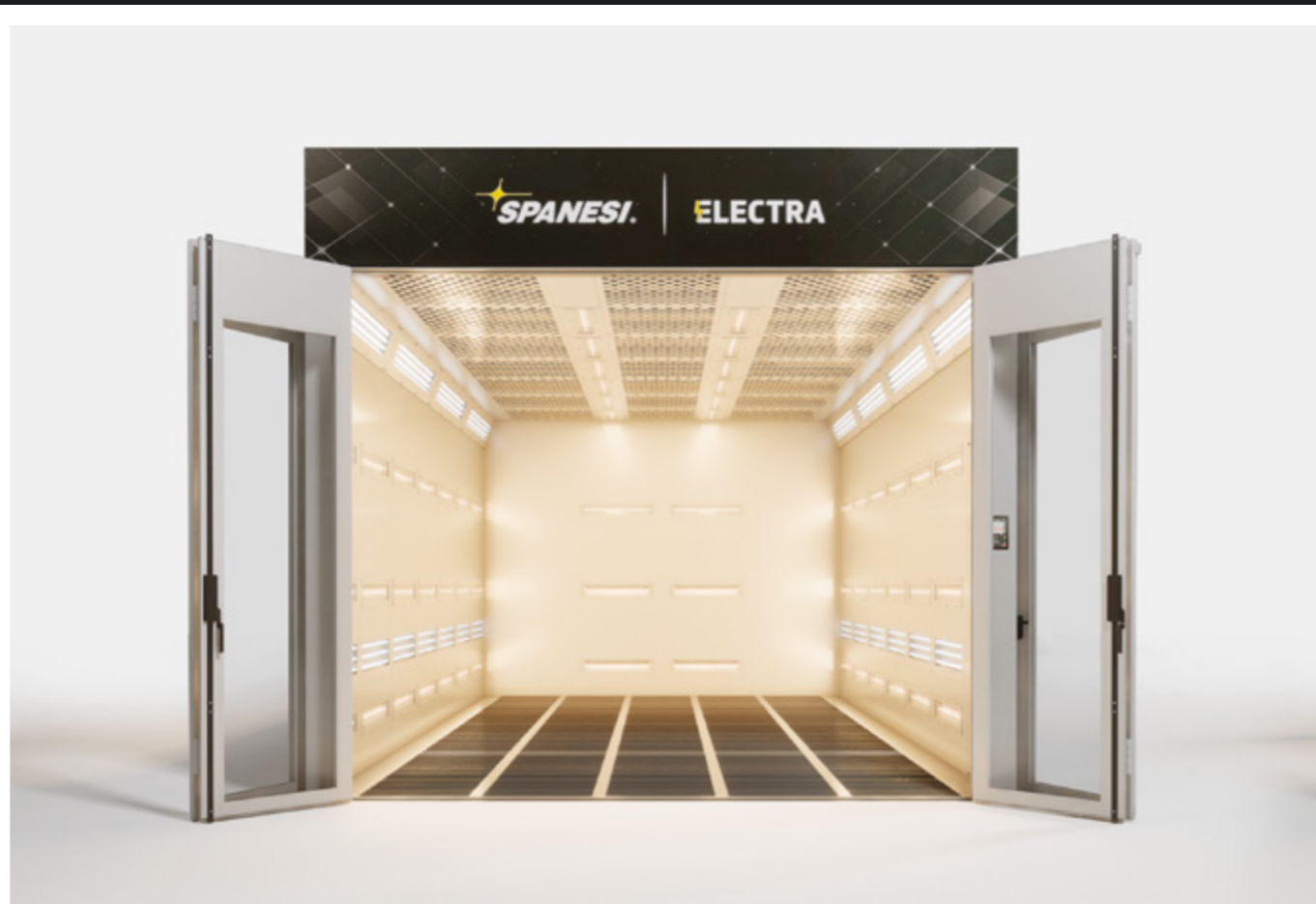

Electra

Customizable spray booth - Ask for quotation

-100%

Energy Costs (Fuel)

The Electra booth is powered exclusively by electricity, which means it can potentially eliminate energy costs if photovoltaic systems are already in place.

+50%

Faster Work Cycles

Doubled daily productivity per work cycle.

Higher Quality

Brilliant finish with reduced car polishing time.

-70%

Drying Time

Thanks to the infrared lamps, the temperature is reached much faster compared to booths equipped with traditional burners.

x2

Doubled annual productivity

Possibility to double annual productivity, thus recovering the investment costs.

Heat recovery efficiency

[BROCHURE](#)

[BACK TO INDEX](#)



Michelangelo

Customizable spray booth - Ask for quotation

USEFUL DIMENSIONS

7000x4000x (h) 2700mm

BASEMENT

5 Lines of grated floor, 700kg/wp capacity

LINE OF LIGHTS

2 slant, 2 waist level - LED 6500K

BURNER

Direct flame burner, 420kW thermal power

ENGINE POWER

11 + 11kW - 34.000m³/h airflow

SERVICE DOOR

1 on one side

[BROCHURE](#)

[BACK TO INDEX](#)



Giotto

Customizable spray booth - Ask for quotation

USEFUL DIMENSIONS	7000x4000x (h) 2700mm
BURNER	TWO-STAGE - 200 kW
ROWS OF LIGHTS	2, SLANT - LED 6500K
THERMAL POWER	200 kW
ENGINE POWER	7,5 + 7,5 kW - 25.000 m ³ /h airflow
CONTROL PANEL	Synoptic

BROCHURE

BACK TO INDEX

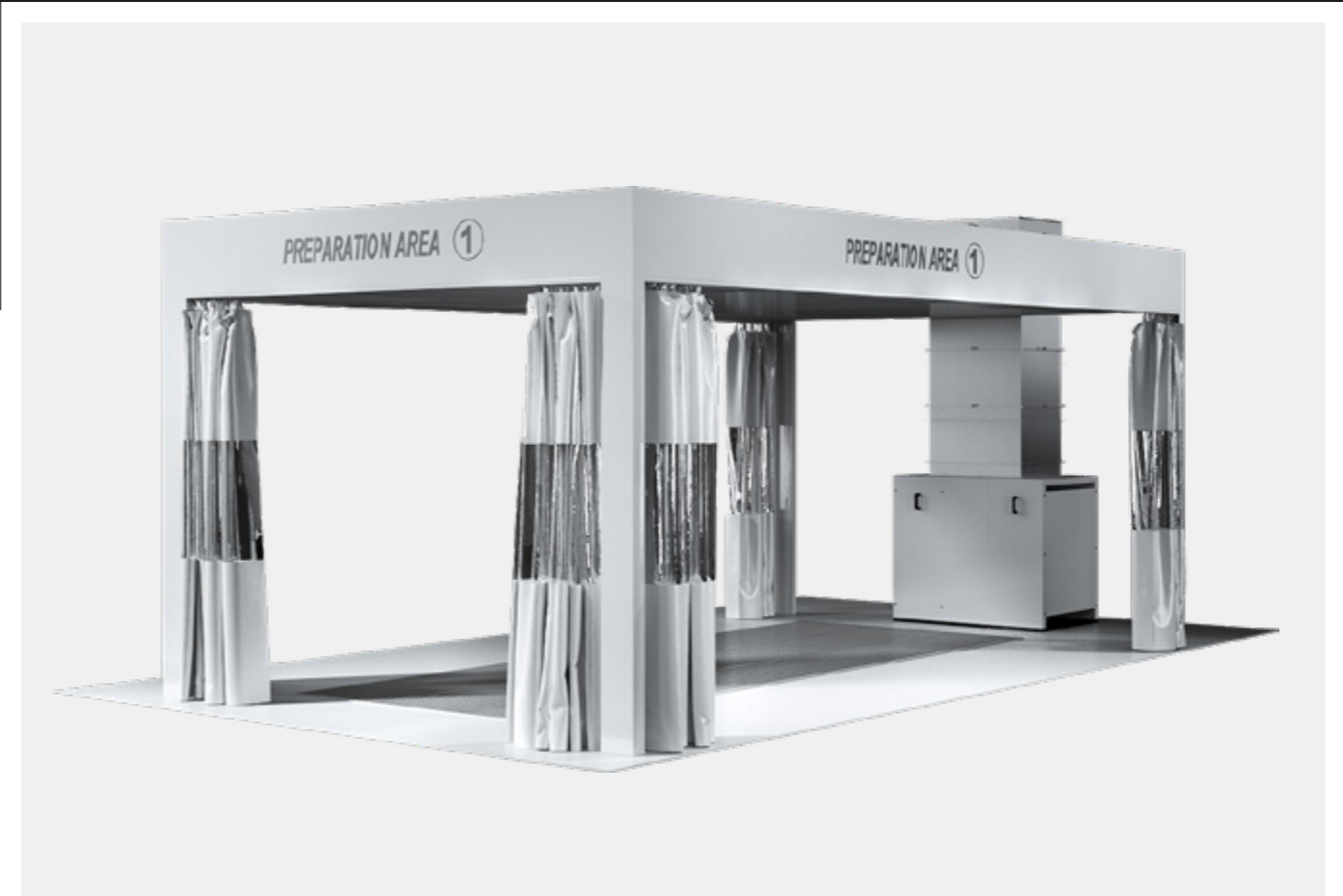

Einstein 1

Customizable spray booth - Ask for quotation

USEFUL DIMENSIONS	7000x4000x (h) 2900mm
SUCTION (DOWNDRAFT)	3 lines of grated floor , 450kg/wp capacity
EXTRACTOR POWER	5,5kW (400V 3Ph+N 50Hz)
NOMINAL AIRFLOW	22.000 m ³ /h
CURTAINS	Manual

BROCHURE

BACK TO INDEX



Einstein 2

Customizable spray booth - Ask for quotation

USEFUL DIMENSIONS 7000x4000x (h) 2900mm

SUCTION (DOWNDRAFT) By means of rear suction wall

EXTRACTOR POWER 5,5kW (400V 3Ph+N 50Hz)

NOMINAL AIRFLOW 22.000 m³/h

CURTAINS Manual

BROCHURE

BACK TO INDEX



Mixing box

Customizable spray booth - Ask for quotation

USEFUL DIMENSIONS 3000x3000x (h) 2700mm

POWER SUPPLY 400V 3Ph+N 50Hz

TOTAL POWER CONSUMPTION 400W

LIGHT FIXTURE LED 6500K 3x 12W

ACCESS Hinged door with glazed window

BROCHURE

BACK TO INDEX



Industrial Spray Booth

Customizable spray booth - Ask for quotation

[BROCHURE](#)

[BACK TO INDEX](#)



Aluminium booth

Fully Customizable - Ask for quotation

USEFUL DIMENSIONS

8000x5000x (h) 3200mm

FRONTAL

4 doors with "MAXI" glazed windows

LINE OF LIGHTS

2 on the top

PANELS INSULATION

Glass wool "Sandwich" type, 52mm thick

[BACK TO INDEX](#)



Buddy

Cod. 91CARRP030

Removing and replacing the grids in the Spray Booths or preparation area will be easy and practical from both the short side and the long side of the grid.

HEIGHT	1061,5 mm
LENGTH	648 mm
DEPTH	371 mm
LOAD CAPACITY	50 Kg

TUTORIAL VIDEO

BACK TO INDEX



Inframatic EVO 2

Cod. 90IMPAE120

Aerial installation infamatic Evolution 2 short waves, motorized semi-automatic 6000x4000 with 3 panels independent with 3 pyrometer; white candles short waves 6x2000W + 3x1500W; reflector, 400V 50Hz 3F+PE

BACK TO INDEX

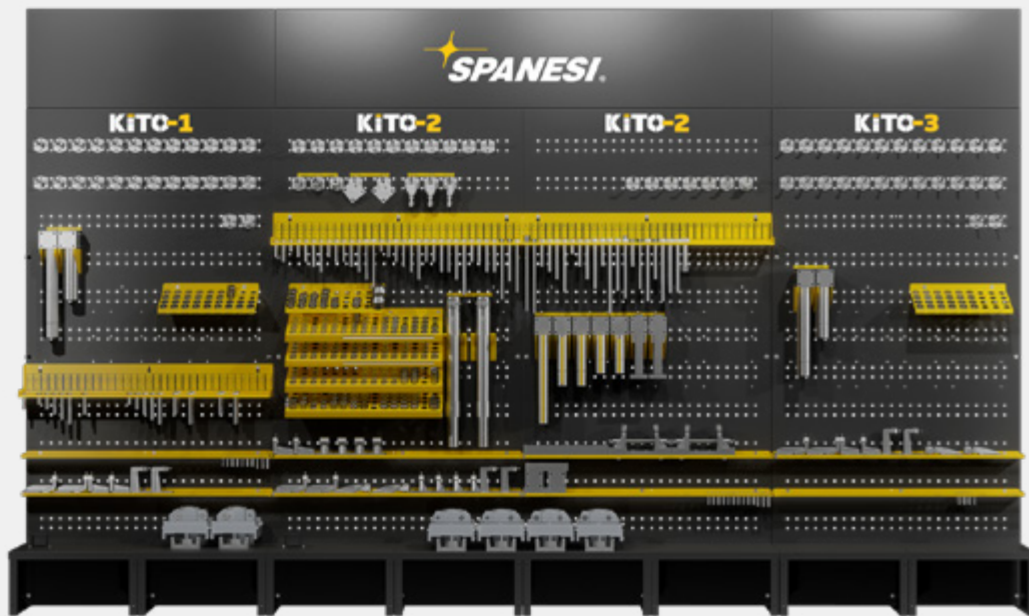

KITO - Holding system for fast repair

Ask for quotation

Kito 1 - 90KITOP010 (on panel)

Kito 1 is a universal quick-anchoring system.

It is used in combination with the 4 clamps provided with the bench. The components allow securing two structural points on the car body when realignment or replacement of a damaged metal sheet is required.

Kito 2 - 90KITOP020 (on panel)

Kito 2 is a universal quick-anchoring system.

It can be used individually or in combination with the 4 clamps provided with the bench. The components allow securing from 4 to 8 structural points on the car body.

Kito 2 is recommended for securing electric vehicles (EV) or any vehicles where clamps cannot be used.

Kito 3 - 90KITOP030 (on panel)

Kito 3 is a universal quick-anchoring system.

Kito 3 is used when the operator needs to secure the car body at 12 to 14 points in combination with Kito 1 and 2. The 6th or 7th crossmember on the frame bench is required.

BROCHURE

BACK TO INDEX



100 TS

Price/Code includes:

- Bench with rack gears
- Lift with control box
- Pulling Column
- 5 Crossbars
- 4 Universal Clamps
- Loading trolley
- Positioning and ascending ramps

LOAD CAPACITY	5000 Kg
LENGTH	5 meters
WIDTH	1,8 meters
LIFTING HEIGHT	1,6 meters
PULLING FORCE	10 Ton

BROCHURE

TUTORIAL VIDEO

BACK TO INDEX

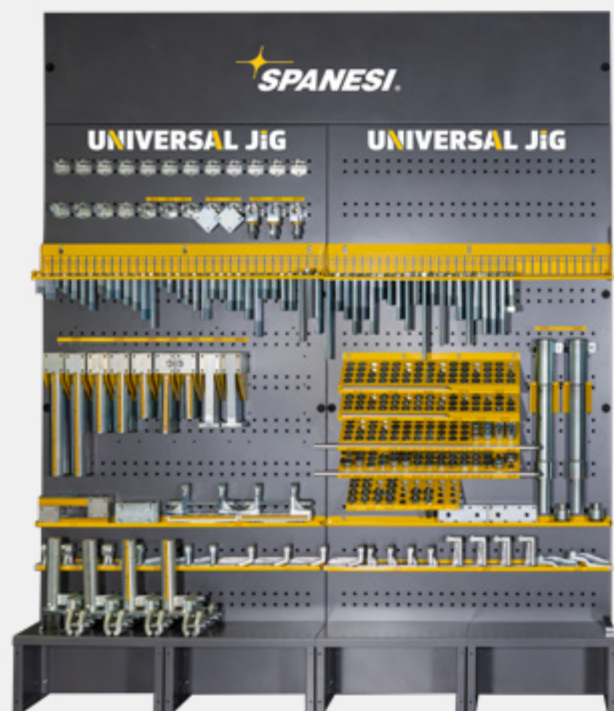

Jig on the wall

Cod. 90SEP103

Price/Code includes:

- 5 crossbars l= 1800 mm
- 10 sliding supports
- accessories and special screws set
- winstar software and 6 months use license

[BACK TO INDEX](#)



90PARM0010

Clamps holder wall complete of accessories

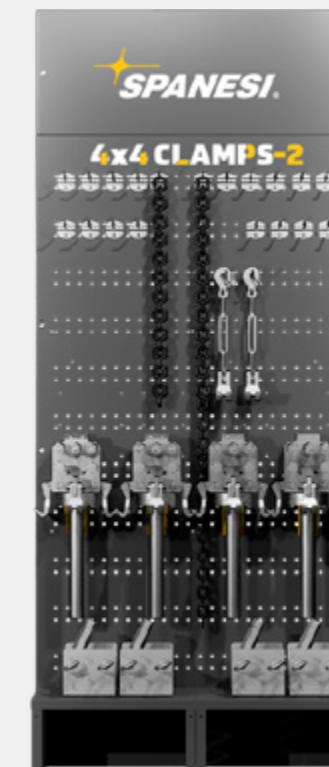

90PARM0020

Clamps holder wall 4x4 clamps-2 complete of all accessories

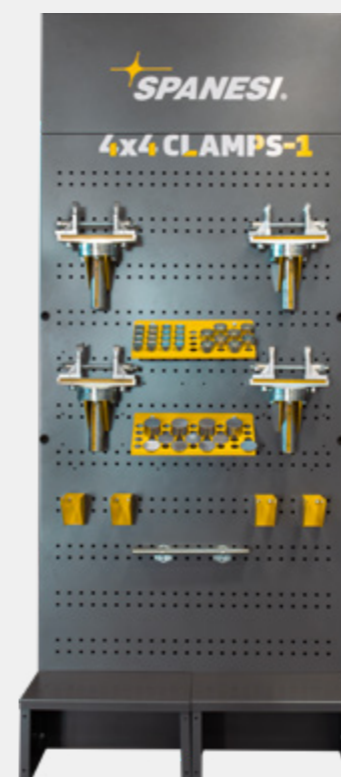

90PARM0030

Clamps holder wall 4x4 clamps-1 complete with accessories



90PARMP010

McPherson on a wall



106/Universal Jig 5m

Cod. 900SABP701

Price/Code includes:

- Bench with rack gears
- Lift with control box
- Pulling Column
- Universal Jig System
- 5 Crossbars
- Loading trolley
- Positioning and ascending ramps
- McPherson system

LOAD CAPACITY	5000 Kg
LENGTH	5 meters
WIDTH	1,8 meters
LIFTING HEIGHT	1,6 meters
PULLING FORCE	10 Ton

BROCHURE

TUTORIAL VIDEO

BACK TO INDEX

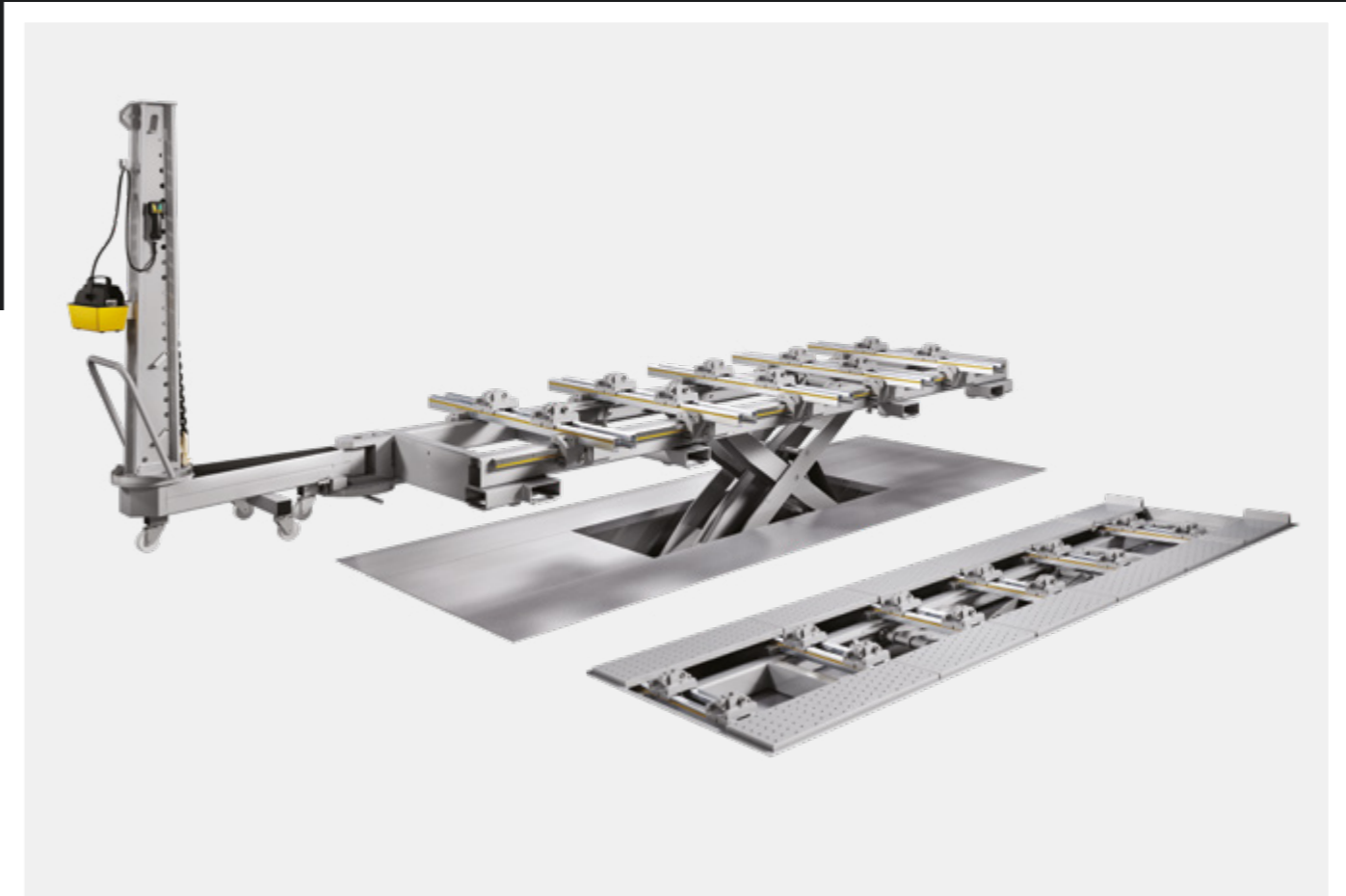

106 Plus

Cod. 900SABP702

Price/Code includes:

- In-floor Bench with rack gears
- Lift with control box
- Pulling Column
- Universal Jig System
- 6 Crossbars
- Loading trolley
- Positioning ramps
- McPherson system

LOAD CAPACITY	5000 Kg
LENGTH	5 meters
WIDTH	1,8 meters
LIFTING HEIGHT	1 meter
PULLING FORCE	10 Ton

BROCHURE

TUTORIAL VIDEO

BACK TO INDEX



106 Ext 6M

Cod. 900SABPA01

Price/Code includes:

- Bench with rack gears
- Lift with control box
- Pulling Column
- Universal Jig System
- 7 Crossbars
- Loading trolley
- Positioning and ascending ramps
- McPherson system

LOAD CAPACITY	5000 Kg
LENGTH	6 meters
WIDTH	1,8 meters
LIFTING HEIGHT	1 meter
PULLING FORCE	10 Ton

BROCHURE

TUTORIAL VIDEO

BACK TO INDEX



Daytona Plus infloor

Price/Code includes:

- Single sliding and fixing ring for pulling columns
- 3 revolving and sliding pulling columns
- In-floor Bench with rack gears
- Lift with control box
- Universal Jig System
- 6 Crossbars
- Positioning ramps
- McPherson system

LOAD CAPACITY	5000 Kg
LENGTH	5 meters
WIDTH	1,8 meters
LIFTING HEIGHT	1,74 meters
PULLING FORCE	10 Ton

BROCHURE

TUTORIAL VIDEO

BACK TO INDEX



Spanesi Truck Line - Repair

Fully Customizable - Ask for quotation

[BROCHURE](#)

[BACK TO INDEX](#)



Spanesi Truck Line - Alignment

Fully Customizable - Ask for quotation

[BROCHURE](#)

[BACK TO INDEX](#)

100 SERIES AND DAYTONA OPTIONS

● 100 SERIES ● DAYTONA



90RINV01 ● ●
Down-Pull adaptor



90201935 ● ●
BMW Clamps



90205215 ●
Extension for vertical pulling column

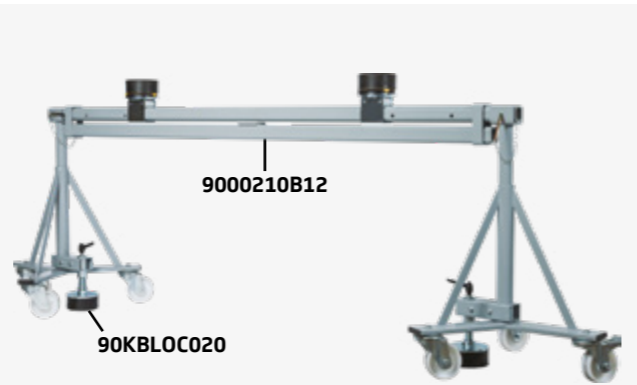

90KBLOC020 ●
Adjustable pads for floor blocking

9000210B12 ●
Reinforcement crossbar



90VERSTM07 ● ●
Electric reinforced winch

100 SERIES AND DAYTONA OPTIONS

● 100 SERIES ● DAYTONA

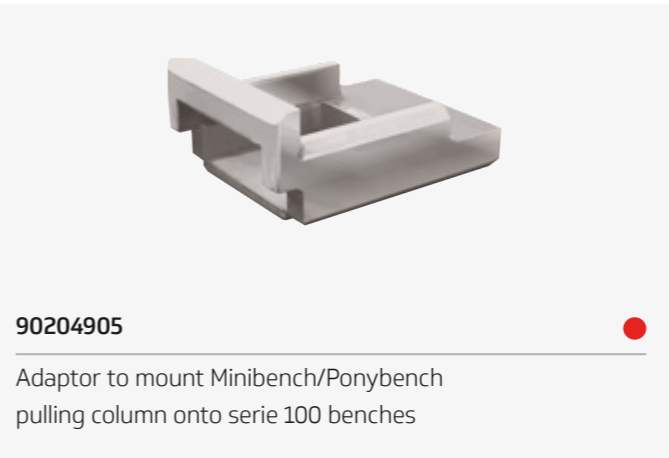

90204905 ●
Adaptor to mount Minibench/Ponybench pulling column onto serie 100 benches

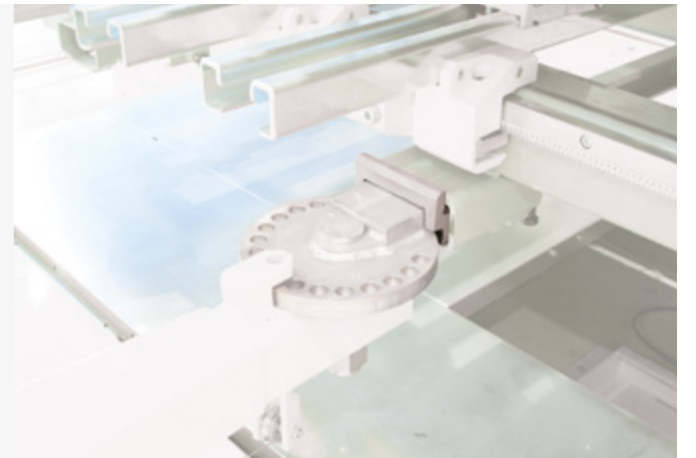

90STARSUP1 ● ●
Wall mounts for platforms



90202580 ● ●
Platforms for the optional sixth crossbar

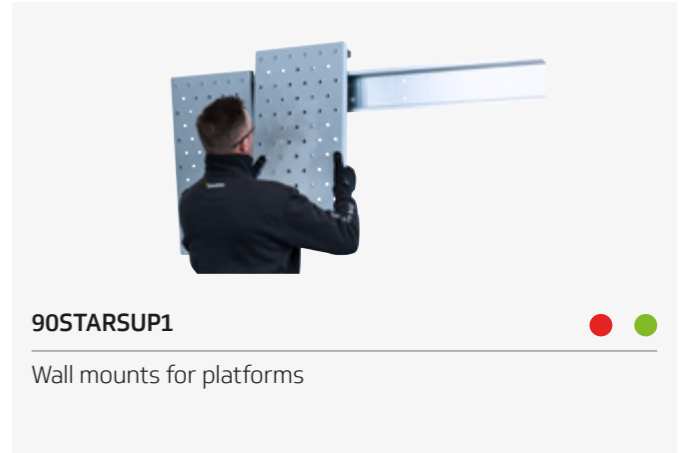

90CS170010 ●
Control Box

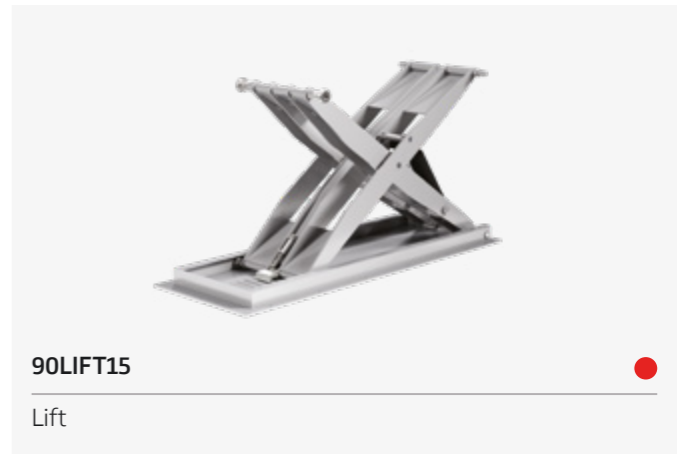

90LIFT15 ●
Lift



90TRST02 ● ●
Crossbar with sliding supports



90TRST04 ● ●
Crossbar without sliding supports

100 SERIES AND DAYTONA OPTIONS

● 100 SERIES ● DAYTONA



90M100T020 ● ●
Clamp kit for high profile / 4WD vehicles
(rear mechanics anchoring)



90M100T010 ● ●
Clamp kit for
high profile / 4WD vehicles



90PANPB010 ● ●
Bushes and spacers' holder shelf

90SETAL010 ● ●
Ergal bushing kit

100 SERIES AND DAYTONA OPTIONS

● 100 SERIES ● DAYTONA

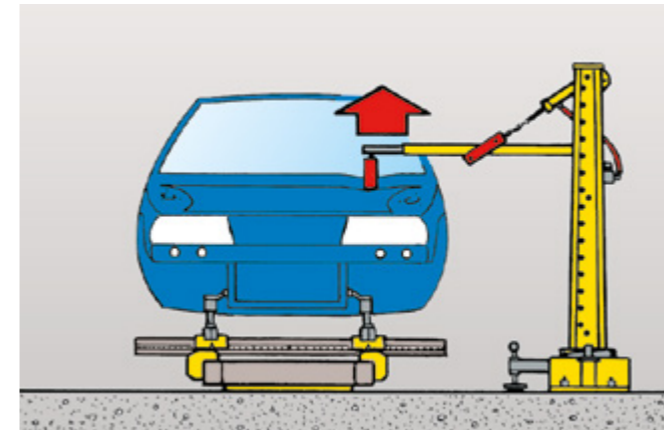

90BRATIR ●
Device for vertical pull

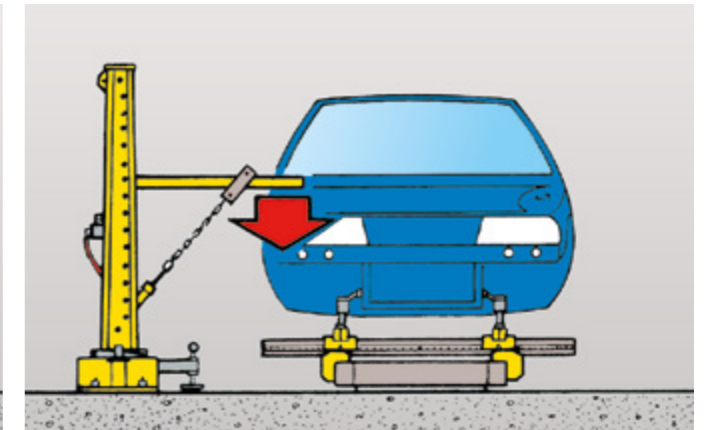

90201860 ●
Telescopic arm with hook

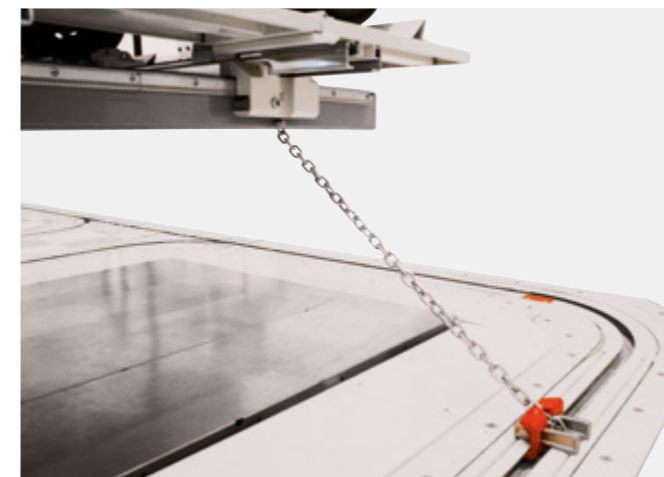

90KCTIR010 ●
Kit 4 counterpulling chains with lockings
on Daytona rings guide



Touch 4.0

Cod. 90TOUCP220

TOUCH ALLOWS MEASURING OF

Vehicle frame and structural items

Mechanical parts

User added points with photos

Wheel and tire alignment

Suspension parts

Comparative measurements

[BROCHURE](#)

[TUTORIAL VIDEO](#)

[BACK TO INDEX](#)



Touch Portable

Cod. 90TOUCP120

TOUCH ALLOWS MEASURING OF

Vehicle frame and structural items

Mechanical parts

User added points with photos

Wheel and tire alignment

Suspension parts

Comparative measurements

[BROCHURE](#)

[TUTORIAL VIDEO](#)

[BACK TO INDEX](#)



Package Car Check

Spanesi Car Check with lift and Touch 4.0

Cod. 90CARCK020

Package Car Check

Spanesi Car Check with Lift and Touch Portable

Cod. 90CARCK010

BROCHURE

BACK TO INDEX



Touch One

Cod. 90TOUC1010

Price/Code includes:

- Touch Arm
- Straight Extension
- Special Curved Extension for External Points
- Touch case
- Adjustable Probe
- Follow-me tool
- Wintouch Software

BROCHURE

BACK TO INDEX



Minibench 2.5 T

Cod. 90MINOSA21

Price/Code includes:

- Minibench with Electrohydraulic scissor lift
- 4 sliding platforms
- 4 support buffers
- 4 standard clamps
- Pulling column
- Control box

LOAD CAPACITY	2500 Kg
LENGTH	2065 mm
LIFTING HEIGHT	1350 mm
MINIMUM HEIGHT	100 mm
PULLING FORCE	6 Ton

BROCHURE

VIDEO

BACK TO INDEX



Minibench Maxiplus

Cod. 90MINOSA73

Price/Code includes:

- Minibench Maxiplus with Electrohydraulic scissor lift
- 4 sliding platforms
- 4 support buffers
- 4 standard clamps
- Pulling column
- Control box

LOAD CAPACITY	3500 Kg
LENGTH	2327 mm
LIFTING HEIGHT	1600 mm
MINIMUM HEIGHT	108 mm
PULLING FORCE	6 Ton

BROCHURE

VIDEO

BACK TO INDEX



Minibench pr maxiplus

Cod.90MINOSA77

Price/Code includes:

- Electrohydraulic scissor lift
- Control box
- Loading platforms

The lift is designed to be installed flush with a basement grates

LOAD CAPACITY	3200 Kg
RISE	1400 mm
MAX. LENGHT PLAT	3655 mm
MAX. WIDTH PLAT.	1900 mm

BROCHURE

BACK TO INDEX



Minieco 2.8T

Cod. 90MINOSA90

Price/Code includes:

- Pneumo-hydraulic lift;
- Pneumatic pump;
- Pneumatic arms;
- Adjustable support buffers

Also available ATEX certified

LOAD CAPACITY	2800 Kg
LENGTH	1650 mm
WIDTH	700 mm
MINIMUM HEIGHT	110 mm
LIFTING HEIGHT	1250 mm

BROCHURE

BACK TO INDEX



Ponybench BT Plus

Cod. 90PONY0333

Price/Code includes:

- Ponybench BT Plus with Electrohydraulic scissor lift
- 4 pneumatic arms
- 4 support buffers
- 4 standard clamps
- Pulling column
- Control box

BROCHURE

BACK TO INDEX



Ponybench BE 15

Cod. 90PONY0411

Price/Code includes:

- Ponybench BE 15 with Electrohydraulic scissor lift
- 4 pneumatic arms
- 4 support buffers
- control box

LOAD CAPACITY	3000 Kg
LENGTH	1500 mm
WIDTH	700 mm
LIFTING HEIGHT	1200 mm

BROCHURE

BACK TO INDEX

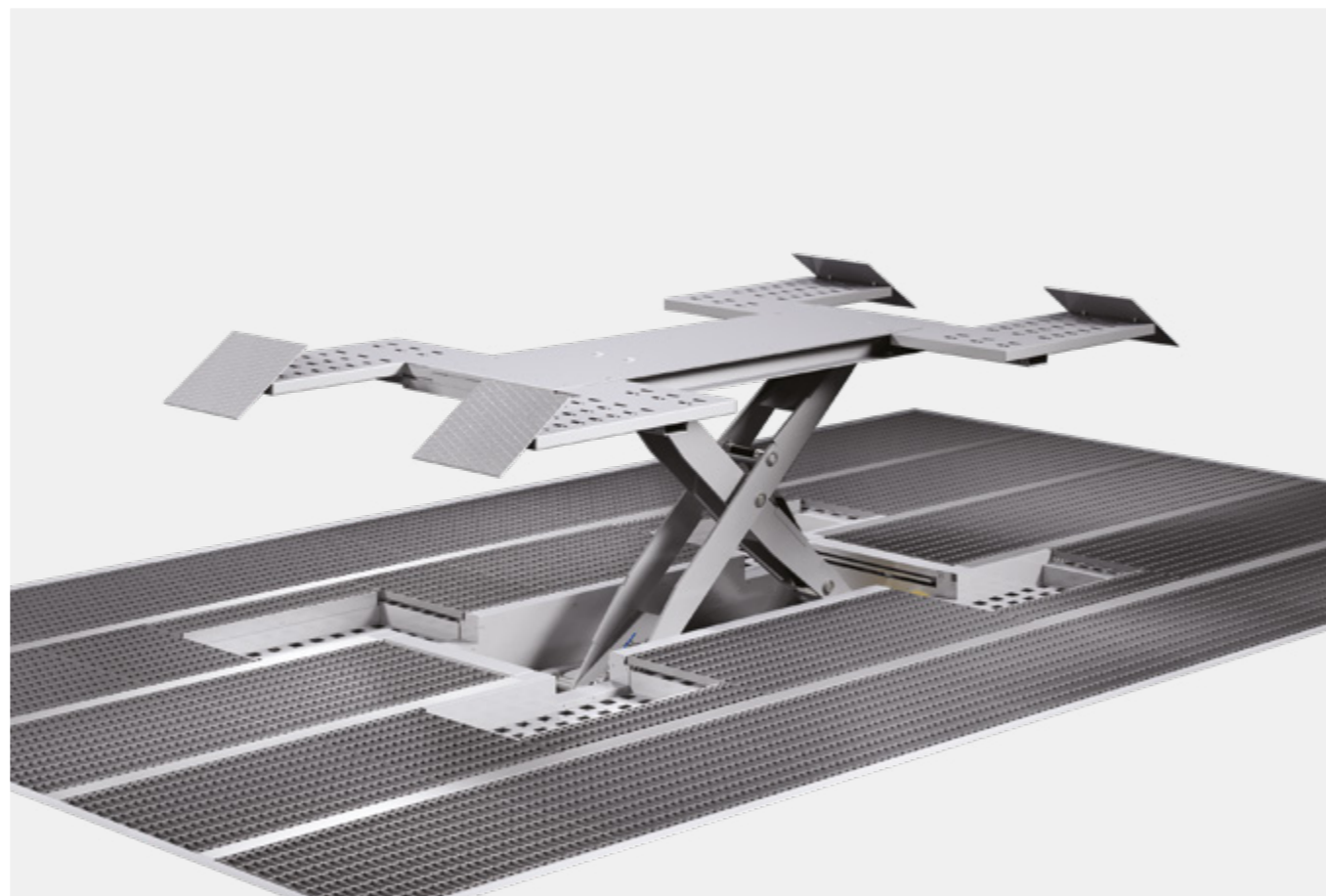

Ponybench PR Plus

Cod. 90TOUCM110

Price/Code includes:

- Ponybench PR Plus with Electrohydraulic scissor lift
- 4 platforms
- control box

Also available ATEX certified

LOAD CAPACITY	3500 Kg
LENGTH	3500 mm
LIFTING HEIGHT	1400 mm

BROCHURE

BACK TO INDEX



Two post Lift - TP 248

Cod. 10002248

Two post Lift:

- Electro-hydraulic two-post lift with asymmetric arms.
- One-piece powder-coated steel columns.
- Three-stage telescopic arms + 4 rubber door stops.
- 80 mm spacers with support brackets.
- Safety: anti-explosion oil pipes, mechanical lock, self-locking arms.
- Electric control panel with safety unlocking + limit bar.
- Dual hydraulic cylinders; Ø11 mm steel wire ropes.

LIFTING CAPACITY	4.5 T
LIFTING HEIGHT	≤ 1900 mm
MOTOR POWER / VOLTAGE	2.2 kW / 380-220 V
SYSTEM PRESSURE	20 MPa
NET WEIGHT	0.75 T
PASSWAY SPACE	2500 / 2830 mm
TRAY MINIMUM HEIGHT	100mm

BROCHURE

BACK TO INDEX



Double Scissor Lift - DS 249

Cod. 10002249

Double Scissor Lift h1900 mm:

- Precision leveling system for fast and accurate adjustment.
- Dual hydraulic interlock + hydraulic lock for operator safety.
- Ultra-low 115 mm profile, lifting up to 1900 mm.
- Extendable platforms: 1470 mm up to 2040 mm.
- Above-ground or flush-mounted installation.
- Solid steel scissor arms for long-term reliability.
- Dual-circuit technology for stability during lifting.

LIFTING CAPACITY	3.5 T
LIFTING HEIGHT	≤ 1900 mm
PLATFORM LENGTH	1470-2040 mm
POWER SUPPLY	3.0 kW
HYDRAULIC PRESSURE	25 MPa
NET WEIGHT	750 kg
MIN. HEIGHT	115 mm

BROCHURE

BACK TO INDEX



Double Scissor Lift - DS 259

Cod. 10002259

Double Scissor Lift h1000 mm:

- Precision leveling system for accurate adjustment.
- Dual hydraulic circuit with anti-explosion valves and safety photocell.
- Ultra-low 110 mm resting height, lifting up to 1000 mm.
- Extendable platforms: 1500 mm up to 2070 mm; 520 mm width each.
- Above-ground or flush-mounted installation.
- Reinforced double-scissor structure with synchronized arms.
- Dual-circuit safety ensuring stable operation.

LIFTING CAPACITY	3.2 T
LIFTING HEIGHT	≤ 1000 mm
PLATFORM LENGTH	1500-2070 mm
POWER SUPPLY	2.2 kW
HYDRAULIC PRESSURE	25 MPa
NET WEIGHT	25 MPa
MIN. HEIGHT	110 mm

BROCHURE

BACK TO INDEX

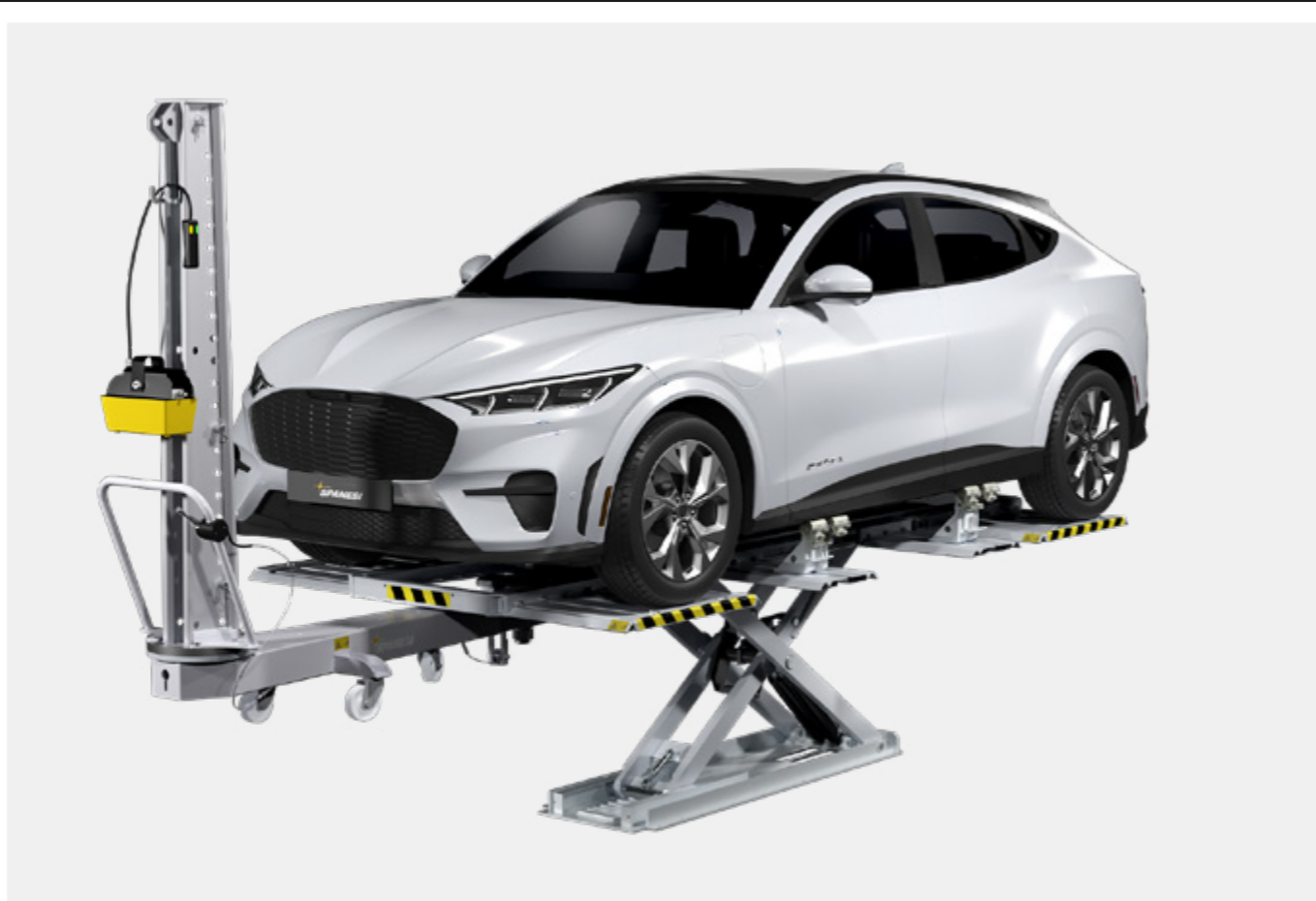

Multibench P3

Price/Code includes:

- Multibench with Electrohydraulic scissor lift
- 12 sliding platforms
- 4 universal clamps
- Pulling column
- Control box

LOAD CAPACITY	3200 kg
LENGTH	3720 mm
LIFTING HEIGHT	1520 mm
MINIMUM HEIGHT	108 mm
PULLING FORCE	10 Ton

BROCHURE

TUTORIAL VIDEO

BACK TO INDEX



Multibench P4

Price/Code includes:

- Multibench with Electrohydraulic scissor lift
- 12 sliding platforms
- Clamp kit for high profile / 4WD vehicles
- 4 universal clamps
- Pulling column
- Control box
- Kit of 4 tripod-trolleys (3 wheels) - h 1250

LOAD CAPACITY	3200 kg
LENGTH	3720 mm
LIFTING HEIGHT	1520 mm
MINIMUM HEIGHT	108 mm
PULLING FORCE	10 Ton

BROCHURE

TUTORIAL VIDEO

BACK TO INDEX



Multibench P7

Price/Code includes:

- Multibench with electrohydraulic scissor lift
- 12 sliding platforms
- Pulling column
- Control box
- 2 Crossbars with bases and longitudinal rails
- 4 Clamps
- Set of N.4 trolleys (H1245mm max loading capacity 5500kg)

LOAD CAPACITY	3200 kg
LENGTH	3720 mm
LIFTING HEIGHT	1520 mm
MINIMUM HEIGHT	108 mm
PULLING FORCE	10 Ton

[BACK TO INDEX](#)

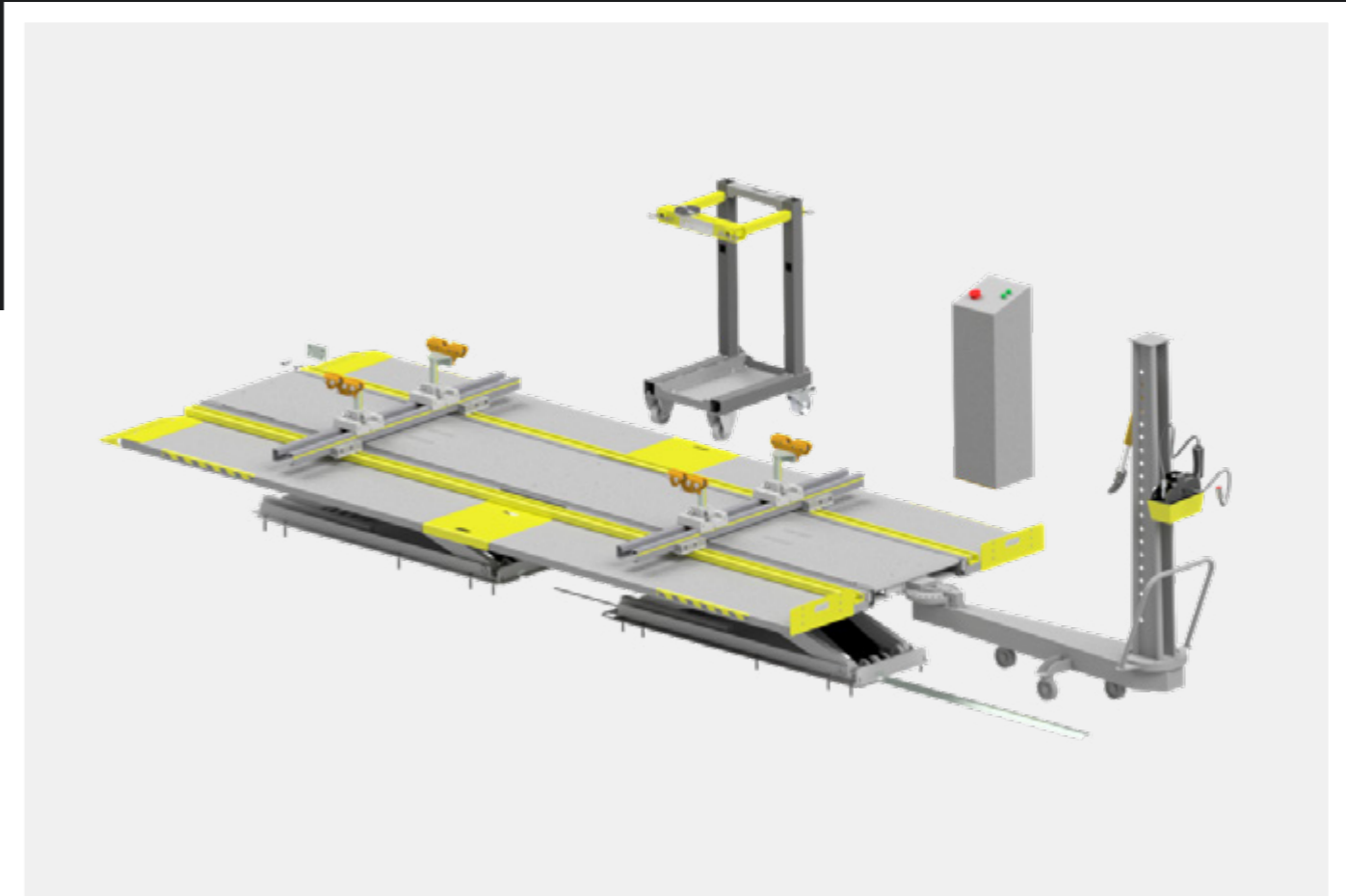

Multibench EXT

Price/Code includes:

- Frame bench with double lift
- Control box
- Platforms
- Wheel stop platforms
- Rail
- 2 Crossbars with bases
- Universal clamps
- Tools kit
- Side Pulling kit (1 piece)
- 10Ton Pulling column
- 4 Wheel trolleys (H1245mm max loading capacity 5500kg)

MAXIMUM LENGTH	5000 mm
MAXIMUM WIDTH	2000 mm
MINIMUM GROUND CLEARANCE	115 mm
MAXIMUM PLATFORM HEIGHT	55 mm
MAXIMUM LIFTING HEIGHT	1400 mm
CAPACITY	5,5 Ton

[BACK TO INDEX](#)



PULL UP! Light

Cod. 90PULUP060

Price/Code includes:

- 5 Sliding Hammers
- 60 Shaped suction cups
- 32 Thread pivots
- 1 Glue gun ø 15mm 450w
- 5 Kg glue sticks

BROCHURE

TUTORIAL VIDEO

BACK TO INDEX



Flash

Cod. 90STR00010

Price/Code includes:

- Flash Pulling System

BROCHURE

TUTORIAL VIDEO

BACK TO INDEX



Twister 6m

Cod. 90TWIS02

Price/Code includes:

- Twister with automatic filter cleaning
- Articulated arm (6m length)
- Pitagora control box
- Pneumatic device with n.04 ANI Connections
- Special plate to fix on wall

BROCHURE

BACK TO INDEX



Typhoon-4B

Cod. 904B0105

ELECTRIC MOTOR POWER	5,5 kW - 400V 3Ph 50Hz
NOMINAL AIR SUPPLY	500 m ³ /h
DIFFERENTIAL PRESSURE	1600mm H ₂ O
MOTOR	n. 01

BROCHURE

BACK TO INDEX



Pinocchio 6m Arm

Cod. 90BA011101

Price/Code includes:

- Articulated arm length 6m
- Special plate to be fixed on wall
- Integrated distributor "Pitagora"
- Differential pressure

BROCHURE

BACK TO INDEX



Pitagora

Cod. 90CEP12301

- Distributor box with electric sockets
- Pneumatic device with no.04 Ani connections
- 230V 16A / 400V 16A 4P

BROCHURE

BACK TO INDEX

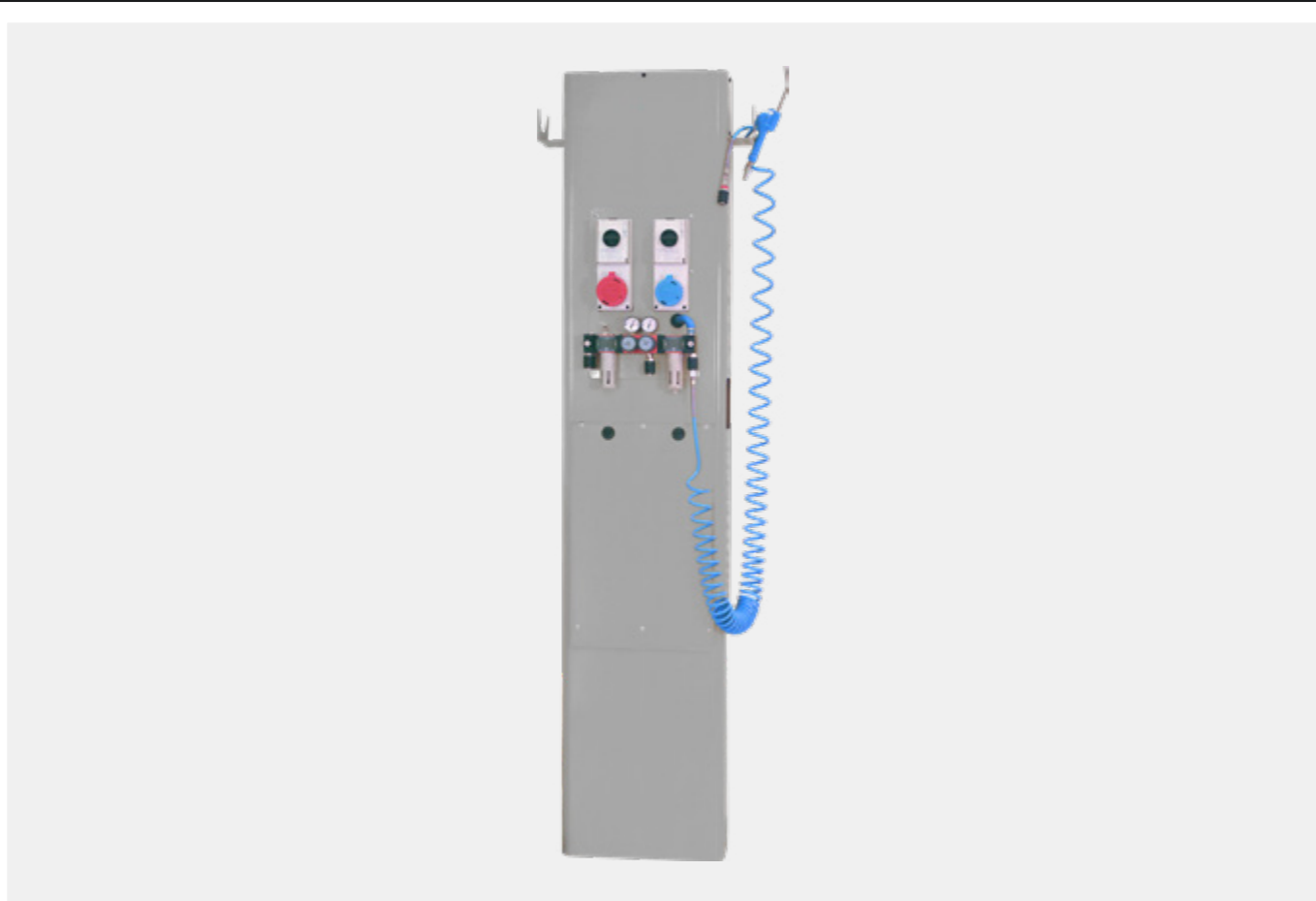

Trial

Cod. 90DISTR201

- Distributor column mod. Trial 230/400v 16a 4 poles
- Pneumatic device with no.04 Ani connections

BROCHURE

BACK TO INDEX



Picasso 3m

Cod. 90CABAP120

Price/Code includes:

- Andrae filter
- Switchboard
- Compressed air filter regulator
- 1 Ceiling light with 2 neon lamps 58w

BACK TO INDEX



Furniture

[BROCHURE](#)

[BACK TO INDEX](#)



Design

[BACK TO INDEX](#)

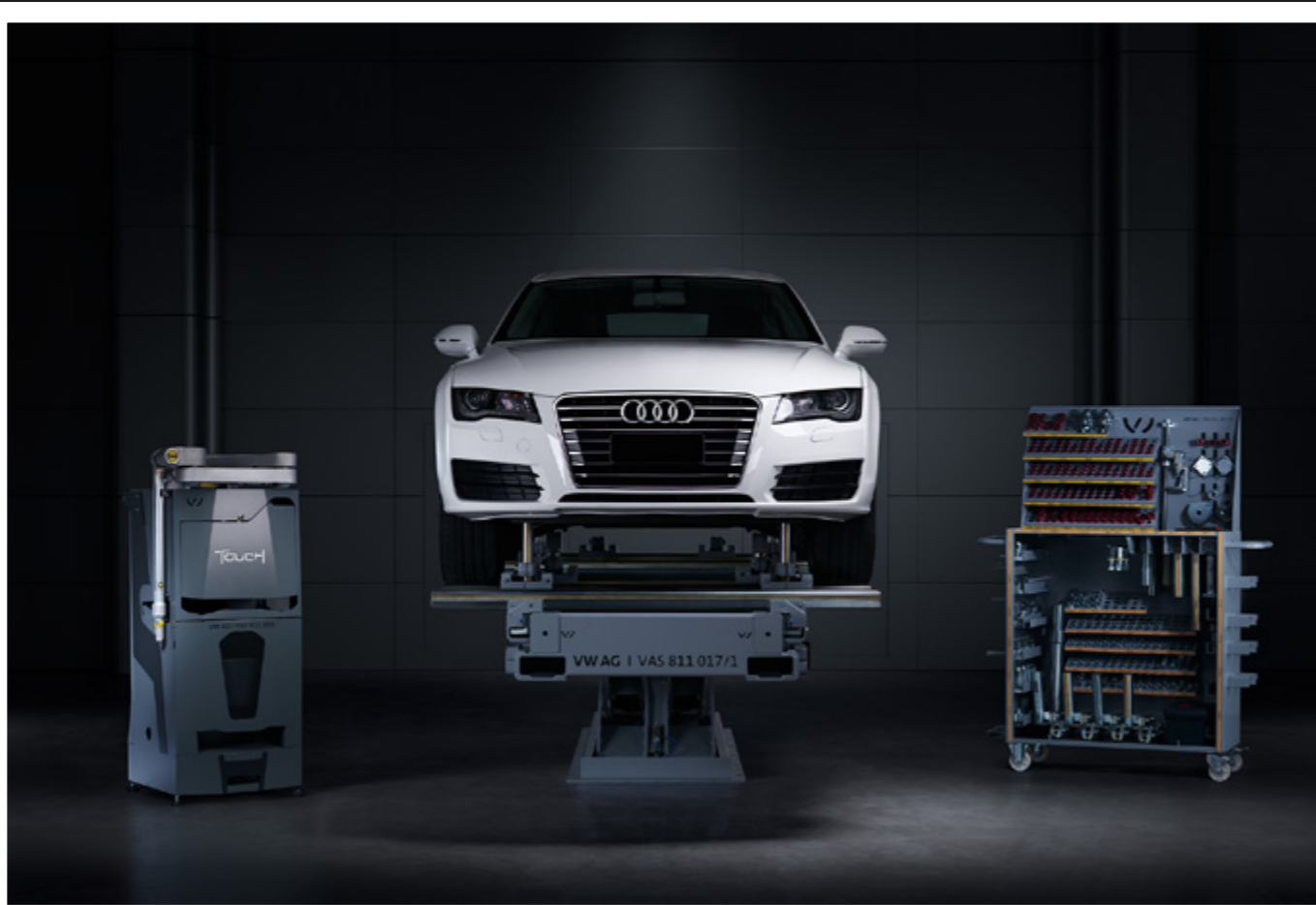

VAS Equipment

[VOLKSWAGEN BROCHURE](#)

[PORSCHE BROCHURE](#)

[BACK TO INDEX](#)



TESLA Equipment

[TESLA BROCHURE](#)

[BACK TO INDEX](#)

BE PART OF THE SPANESI ACADEMY

Hands-on training, official procedures, and real-world expertise delivered by the people who develop and use this technology every day.

Grow, improve, and make your network more autonomous and reliable.

Request information or book your course.

DISCOVER THE NEW SPANESI ACADEMY

VISIT & TRAINING FORM

Performance and Design

Spanesi S.p.A.

Via Praarie 56/II
35010 San Giorgio delle Pertiche PD
tel +(39) 049 933 32 11
www.spanesi.com - info@spanesi.it